

UPQC for Improvement Power Quality.

Dr.S Kamakshaiah¹ Ashwini Kumar²

^{1,2}Dept of EEE, SreeDattha Institute of Engineering and Science

ABSTRACT: This proposed new concept of optimal utilization of a unified power quality conditioner (UPQC) with a power angle control approach is illustrated. The active power control approach is used to compensate voltage sag/swell and is integrated with theory of power angle control (PAC) of UPQC to coordinate the load reactive power between the two inverters. The series inverter of UPQC is controlled to perform simultaneous 1) voltage sag/swell compensation and 2) load reactive power sharing with the shunt inverter. Since the series inverter simultaneously delivers active and reactive powers, this concept is named as UPQC-S (S for complex power). A detailed mathematical analysis, to extend the PAC approach for UPQC-S, is presented in this paper. MATLAB/SIMULINK-based simulation results are discussed to support the developed concept.

Key Words: UPFC, PAC, UPQC, UPQC-S

I. 1.INTRODUCTION

The modern power distribution system is becoming highly vulnerable to the different power quality problems. The extensive use of nonlinear loads is further contributing to increased current and voltage harmonics issues. Furthermore, the penetration level of small/large-scale renewable energy systems based on wind energy, solar energy, fuel cell, etc., installed at distribution as well as transmission levels is increasing significantly. This integration of renewable energy sources in a power system is further imposing new challenges to the electrical power industry to accommodate these newly emerging distributed generation systems. To maintain the controlled power quality regulations, some kind of compensation at all the power levels is becoming a common practice. At the distribution level, UPQC is a most attractive solution to compensate several major power quality problems. The general block diagram representation of a UPQC-based system is shown in Fig. 1. It basically consists of two voltage source inverters connected back to back using a common dc bus capacitor. This paper deals with a novel concept of optimal utilization of a UPQC.

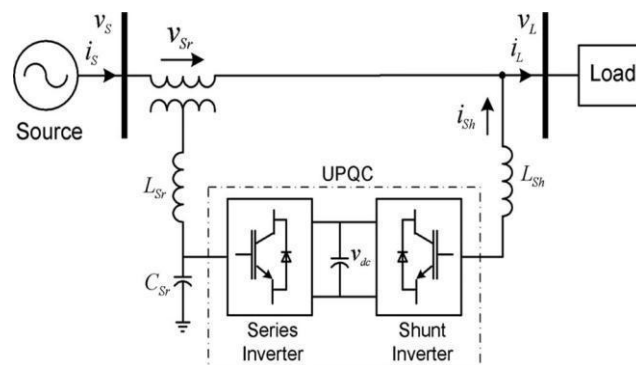

Fig.1. Unified power quality conditioner (UPQC) system configuration.

The voltage sag/swell on the system is one of the most important power quality problems. The voltage sag/swell can be effectively compensated using a dynamic voltage restorer, series active filter, UPQC, etc.. Among the available power quality enhancement devices, the UPQC has better sag/swell compensation capability. Three significant control approaches for UPQC can be found to control the sag on the system: 1) active power control approach in which an in-phase voltage is injected through series inverter, popularly known as UPQC-P; 2) reactive power control approach in which a quadrature voltage is injected [23], [24], known as UPQC-Q; and 3) a minimum VA loading approach in which a series voltage is injected at a certain angle, in this paper called as UPQC-VAmin. In a minimum VA loading approach, the series inverter voltage is injected at an optimal angle with respect to the source current. Besides the series inverter injection, the current drawn by the shunt inverter, to maintain the dc link voltage and the overall power balance in the network, plays an important role in determining the overall UPQC VA loading. The reported paper on UPQC-VAmin is concentrated on the optimal

VA load of the series inverter of UPQC especially during voltage sag condition. The PAC concept suggests that with proper control of series inverter voltage the series inverter successfully supports part of the load reactive power demand, and thus reduces the required VA rating of the shunt inverter. The PAC of UPQC concept determines the series injection angle by estimating the power angle δ . Similar to PAC of UPQC, the reactive power flow control utilizing shunt and series inverters is also done in a unified power flow controller (UPFC). A UPFC is utilized in a power transmission system whereas a UPQC is employed in a power distribution system to perform the shunt and series compensation simultaneously. The primary objective of a UPFC is to control the flow of power at fundamental frequency. In this paper, the concept of PAC of UPQC is further expanded for voltage sag and swells conditions. This modified approach is utilized to compensate voltage sag/swell while sharing the load reactive power between two inverters. Since the series inverter of UPQC in this case delivers both active and reactive powers, it is given the name UPQCS (S for complex power.)

A. Proposed Project

- 1) The series inverter of UPQC-S is utilized for simultaneous voltage sag/swell compensation and load reactive power compensation in coordination with shunt inverter.
- 2) In UPQC-S, the available VA loading is utilized to its maximum capacity during all the working conditions contrary to UPQC-V_{min} where prime focus is to minimize the VA loading of UPQC during voltage sag condition.
- 3) The concept of UPQC-S covers voltage sag as well as swell scenario.

In this paper, a detailed mathematical formulation of PAC for UPQC-S is carried out. The feasibility and effectiveness of the proposed UPQC-S approach are validated by simulation as well as experimental results.

2. U.P.F.C

The UPFC is a combination of a static compensator and static series compensation. It acts as a shunt compensating and a phase shifting device simultaneously.

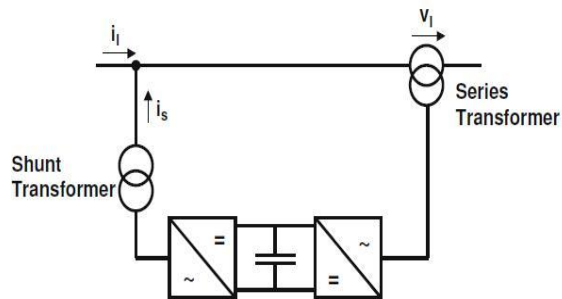

Fig.2.Principle configuration of an UPFC

The UPFC consists of a shunt and a series transformer, which are connected via two voltage source converters with a common DC-capacitor. The DC-circuit allows the active power exchange between shunt and series transformer to control the phase shift of the series voltage. The series converter needs to be protected with a Thyristor bridge.

II. CONCEPT OF PAC

The concept of PAC of UPQC suggests that with proper control of the power angle between the source and load voltages, the load reactive power demand can be shared by both shunt and series inverters without affecting the overall UPQC rating. The phasor representation of the PAC approach under a rated steady-state condition is shown in Fig.3. According to this theory, a vector \vec{V}_{Sr} with proper magnitude V_{Sr} and phase angle ϕ_{Sr} when injected through series inverter gives a power angle δ boost between the source V_s and resultant load V'_L voltages maintaining the same voltage magnitudes. This power angle shift causes a relative phase advancement between the supply voltage and resultant load current I'_L , denoted as angle β .

For a rated steady-state condition
 $|V_s| = |V_L| = |V_s^*| = |V_L^*| = k \quad (1)$
 Using Fig. 3, phasor \vec{V}_{Sr} can be defined as

$$\vec{V}_{Sr} = |V_{Sr}| \angle \varphi_{Sr}$$

$$= (k \cdot \sqrt{2} \cdot \sqrt{1 - \cos \delta}) \angle \left\{ 180^\circ - \tan^{-1} \left(\frac{\sin \delta}{1 - \cos \delta} \right) \right\}$$

$$= (k \cdot \sqrt{2} \cdot \sqrt{1 - \cos \delta}) \angle \left(\frac{90^\circ + \delta}{2} \right)$$

$$\delta = \sin^{-1} \left(\frac{Q_{Sr}}{P_L} \right) \quad (2)$$

Where

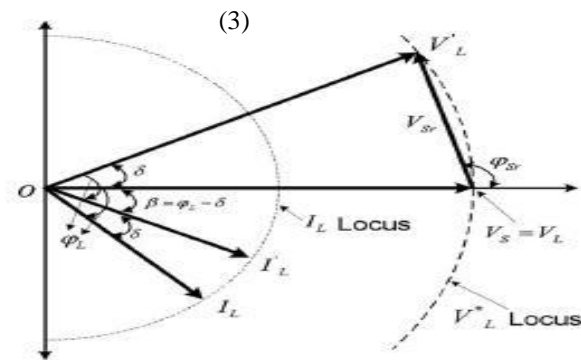

Fig.3. Concept of PAC of UPQC

A. Voltage SAG/SWELL Compensation Utilizing UPQC-P and UPQC-Q

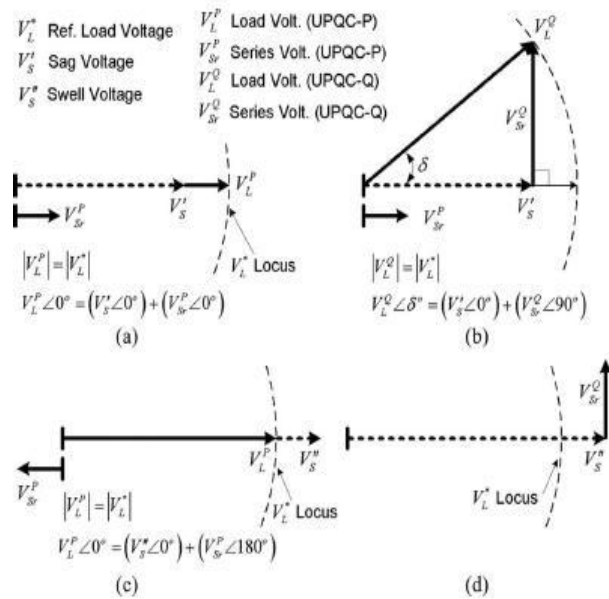
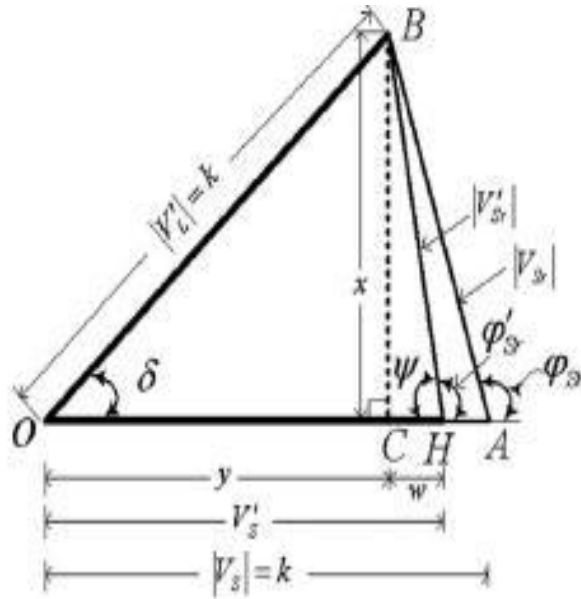

Fig. 4 Voltage sag and swell compensation using UPQC-P and UPQC-Q: phasor representation. (a) Voltage Sag (UPQC-P). (b) Voltage Sag (UPQC-Q). (c) Voltage Swell (UPQC-P). (d) Voltage Swell (UPQC-Q).

The voltage sag on a system can be compensated through active power control and reactive power control methods. Fig.4 shows the phasor representations for voltage sag compensation using active power control as in UPQC-P [see Fig. 4(a)] and reactive power control as in UPQC-Q [see Fig. 4(b)]. Fig. 4(c) and (d) shows the compensation



capability of UPQC-P and UPQC-Q to compensate a swell on the system. For a voltage swell compensation using UPQC-Q [see Fig. d(d)], the quadrature component injected by series inverter does not intersect with the rated voltage locus. Thus, the UPQC-Q approach is limited to compensate the sag on the system.

B. PAC Approach Under Voltage SAG Condition

Consider that the UPQC system is already working under PAC approach, i.e., both the inverters are compensating the load reactive power and the injected series voltage gives a power angle δ between resultant load and the actual source voltages. If a sag/swell condition occurs on the system, both the inverters should keep supplying the load reactive power, as they were before the sag.

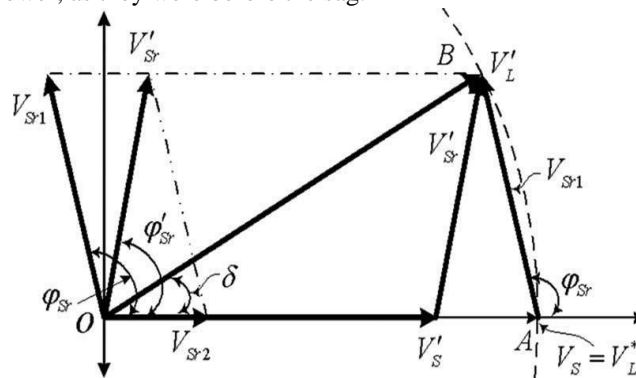

Fig.5 Phasor representation of the proposed UPQC-S approach under voltage sag condition.

Let us represent a vector \vec{V}_{sr1} responsible to compensate the load reactive power utilizing PAC concept and vector

\vec{V}_{sr2} responsible to compensate the sag on the system using active power control approach. Thus, for simultaneous compensation, as noticed from Fig.5, the series inverter should now supply a component which would be the vector

sum of \vec{V}_{sr1} and \vec{V}_{sr2} . This resultant series inverter voltage

\vec{V}'_{sr} will maintain the load voltage magnitude at a desired level such that the drop in source voltage will not appear across the load terminal.

For load reactive power compensation using PAC concept

$$\vec{V}_{Sr1} = \vec{V}'_L - \vec{V}_S \quad (4)$$

$V_{Sr1} \angle \varphi_{Sr} = V'_L \angle \delta - V_S \angle 0^\circ$. (5) For voltage sag compensation using active power control approach

$$\vec{V}_{Sr2} = \vec{V}'_L - \vec{V}'_S \quad (6)$$

$V_{Sr2} \angle 0^\circ = V'_L \angle 0 - V'_S \angle 0^\circ$. (7) For simultaneous load reactive power and sag compensation

$$V'_{Sr} \angle \varphi'_{Sr} = V_{Sr1} \angle \varphi_{Sr} + V_{Sr2} \angle 0. \quad (8)$$

(i) Series Inverter Parameter Estimation under Voltage Sag

In this section, the required series inverter parameters to achieve simultaneous load reactive power and voltage sag compensations are computed. Fig. 6 shows the detailed phasor diagram to determine the magnitude and phase of series injection voltage.

Fig. 6 Detailed phasor diagram to estimate the series inverter parameters for the proposed UPQC-S approach under voltage sag condition.

The voltage fluctuation factor k_f which is defined as the ratio of the difference of instantaneous supply voltage and rated load voltage magnitude to the rated load voltage magnitude is represented as

$$k_f = \frac{V_S - V'_L}{V'_L}$$

	(9)
Representing (9) for sag condition under PAC	
	(1 0)
Let us define	
$1 + k_f = n_0$	(11)
To compute the magnitude of	, from CHB in Fig. 6

$$k_f = \frac{V'_S - V'_L}{V'_L} = \frac{V'_S - k}{k}$$

$$\vec{V}'_{Sr}$$

$$w = l(CH) = n_0 \cdot k - y \quad (12)$$

$$|V'_{Sr}| = k \cdot \sqrt{1 + n_0^2 - 2 \cdot n_0 \cdot \cos \delta}. \quad (13) \text{ To compute the phase of } \vec{V}'_{Sr}$$

$$\angle CHB = \angle \psi = \tan^{-1} \left(\frac{x}{w} \right) = \tan^{-1} \left(\frac{\sin \delta}{n_0 - \cos \delta} \right). \quad (14)$$

Therefore,

$$\angle \varphi'_{Sr} = 180^\circ - \angle \psi. \quad (15)$$

Equations (13) and (15) give the required magnitude and phase of series inverter voltage of UPQC-S.

(ii) Shunt Inverter Parameter Estimation Under Voltage Sag

The phasor diagram based on different currents is represented in Fig. 7. The current I_{Sh} represents the required

current if the shunt inverter is used alone to compensate the total load reactive power demand. Thus, to support the series inverter to inject the required voltage for load reactive power and sag compensations, the shunt inverter should now deliver the current I_{Sh} . Fig. 8 represents the phasor diagram to compute the shunt inverter injected current magnitude and its phase angle.

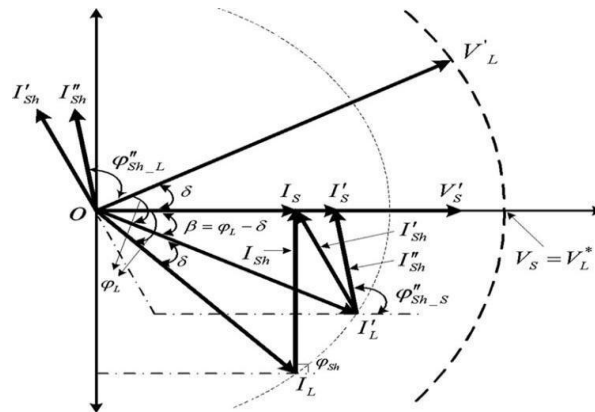

Fig. 7. Current-based phasor representation of the proposed UPQC-S approach under voltage sag condition.

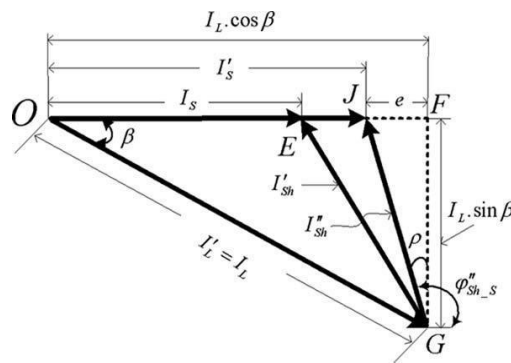

Fig. 8. Detailed phasor diagram to estimate the shunt inverter parameters

To support the active power required during voltage sag condition, the source delivers the extra source current. During voltage sag

$$I_s = \frac{I_L}{1 + k_f} \cdot \cos \varphi_L.$$

on the system using active power control approach. For simultaneous compensation, the series inverter should supply the \vec{V}_{Sr1} component to support the load reactive power and \vec{V}_{Sr3} to compensate the swell on the system. The

resultant series injected voltage \vec{V}_{S1}'' would maintain the load voltage magnitude at a desired level while supporting the load reactive power.

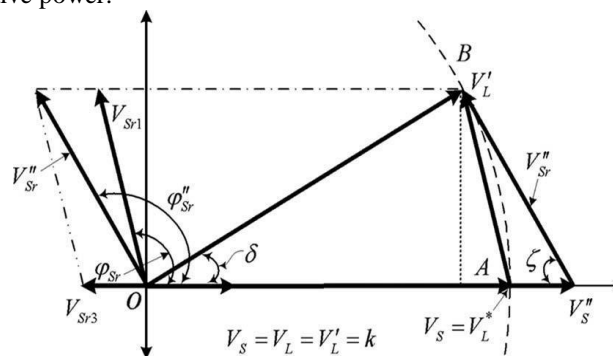
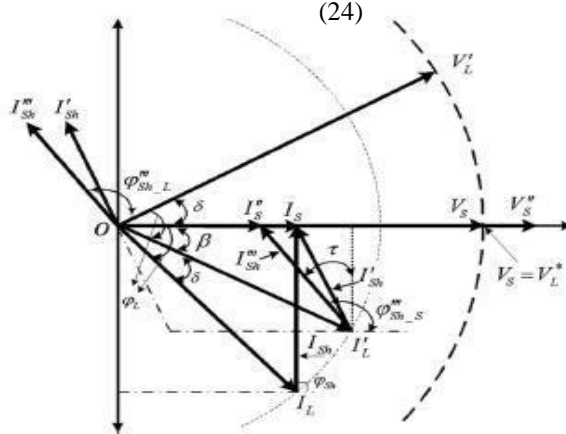

Fig 9. Phasor representation of the proposed UPQC-S approach under voltage Swell condition.

For voltage swell compensation using active power control approach

$$\vec{V}_{Srs} = \vec{V}_L^* - \vec{V}_S^g \quad (24)$$



	(16)	
L	(17)	Fig. 10. Current-based phasor representation of the proposed
e		
t		
l		
$\frac{1}{1+k_f} = k_o.$		

Therefore,	UPQC-S approach	
	Under voltage swell condition.	
In GFJ (see Fig. 5.6)		
	For simultaneous load reactive power and voltage swell compensations	
	For series inverter	

Equations (20) and (23) give the required magnitude and phase angle of a shunt inverter .	Fig.10shows the phasor representation for different currents under PAC of UPQC-S under a voltage swell condition.	
C. PAC Approach Under Voltage SWELL Condition	This reduced shunt inverter current is represented as . For shunt inverter (see Fig. 5.8)	
The phasor representation for PAC of UPQC-S during a voltage swell on the system is shown in Fig. 9. Let us represent a vector V_{Sr3} responsible to compensate the swell		

31)

$$\angle \varphi'''_{Sh-L} = (\angle \tau + 90^\circ) - \delta. \tag{32}$$

It can be noted that the equations for voltage sag and swell compensation utilizing the PAC of UPQC-S are identical.

D. ACTIVE-REACTIVE POWER FLOW THROUGH UPQC-S

The per-phase active and reactive powers flow through the UPQC-S during the voltage sag/swell is determined in this section.

For active power

$$P'_{Sh} = V'_S \cdot I''_{Sh} \cdot \cos \varphi''_{Sh-S}.$$

From Fig.8

$$P'_{Sh} = n_O \cdot k \cdot I''_{Sh} \cdot (-\sin \rho)$$

$$P_{Sh,PAC} = -\frac{(k \cdot I_L) \cdot (\cos \beta - k_O \cdot \cos \varphi_L)}{k_O}.$$

For reactive power

$$Q'_{Sh} = V'_S \cdot I''_{Sh} \cdot \sin \varphi''_{Sh-S}.$$

From Fig. 8

$$(45) \quad Q'_{Sh} = n_O \cdot k \cdot I''_{Sh} \cdot \cos(\rho)$$

(46)

(47)

(48)

(i) Series Inverter of UPQC-S

For active power

$$P'_{Sr} = V'_{Sr} \cdot I'_S \cdot \cos \varphi'_{Sr}.$$

From Fig. 6

$$P'_{Sr} = V'_{Sr} \cdot I'_S \cdot \cos(180^\circ - \psi)$$

$$P'_{Sr} = V'_{Sr} \cdot I'_S \cdot (-\cos \psi)$$

$$P'_{Sr} = -V'_{Sr} \cdot I'_S \cdot \left(\frac{w}{V'_{Sr}}\right)$$

$$P'_{Sr} = -I'_S \cdot k \cdot (n_O - \cos \delta).$$

(49)

$$Q_{Sh,PAC} = \frac{(k \cdot I_L) \cdot (\sin \beta)}{k_O} \quad (50)$$

Using (47) and (50), the active and reactive power flow through shunt inverter of UPQC-S during voltage sag/swell condition can be calculated and utilized to determine the overall UPQC-S VA loading

(37)

The increase I'_S or decrease I''_S in the source current magnitudes during the voltage sag or swell condition, respectively, is represented as

$$I'_S = I''_S = k_O \cdot I_L \cdot \cos \varphi_L \quad (38)$$

Therefore,

$$P_{Sr,PAC} = P'_{Sr} = -k_O \cdot (n_O - \cos \delta) \cdot (P_L)$$

(iii) UPQC-S CONTROLLER

A detailed controller for UPQC based on PAC approach is described. Furthermore, the power angle δ is maintained at constant value under different operating conditions. Therefore, the reactive power shared by the series inverter and hence by the shunt inverter changes as given by (43) and (51).

(39) MATLAB CIRCUITS

For reactive power

$$Q'_{Sr} = V'_{Sr} \cdot I'_S \cdot \sin \varphi'_{Sr} \quad (40)$$

$$Q'_{Sr} = V'_{Sr} \cdot I'_S \cdot \sin(180^\circ - \psi) \quad (41)$$

$$Q'_{Sr} = V'_{Sr} \cdot I'_S \cdot \sin \psi \quad (42)$$

$$Q'_{Sr} = V'_{Sr} \cdot I'_S \cdot \left(\frac{x}{V_{Sr}} \right) \quad (43)$$

Using (39) and (44), the active and reactive power flow through series inverter of UPQC-S during voltage sag/swell condition can be calculated.

Below figure 12 gives the simulink diagram of proposed method.

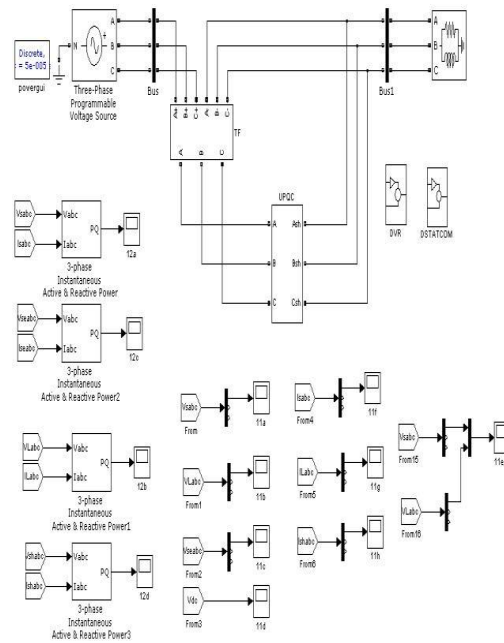

(ii) Shunt Inverter of UPQC-S

The active and reactive power handled by the shunt inverter as seen from the source side is determined as follows

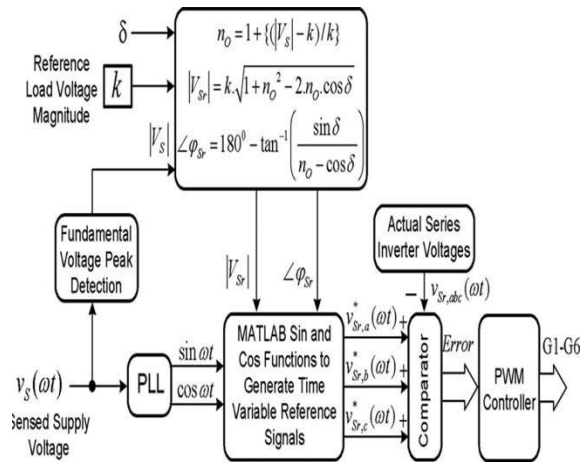
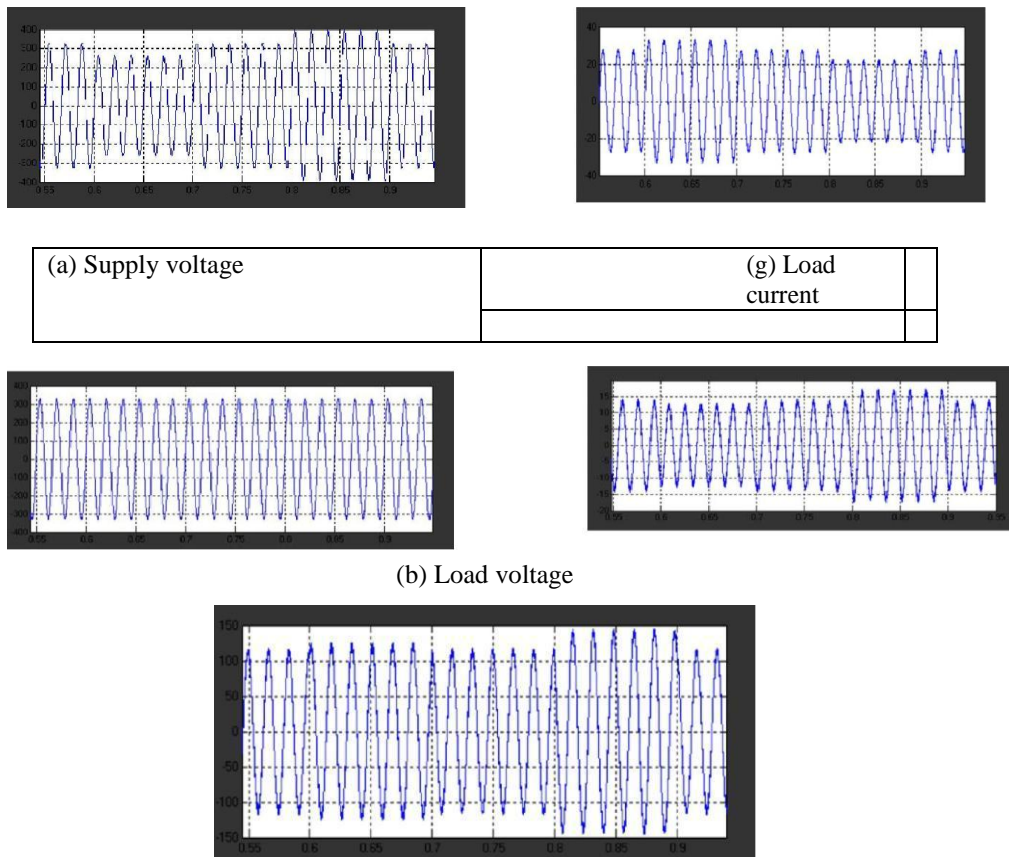

Fig. 11 Reference voltage signal generation for the series inverter of the Proposed UPQC-S approach.
Fig12

III. RESULTS

Simulation results: performance of the proposed UPQC-S approach under voltage sags and swells conditions is shown in below figures.



(c) Series inverter injected voltage

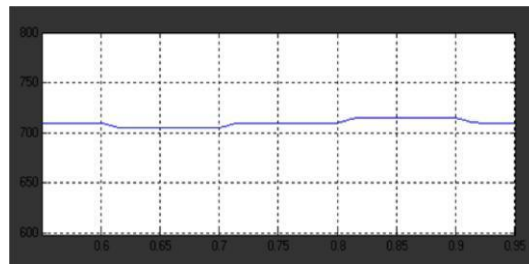

(d) Self-supporting dc bus voltage.

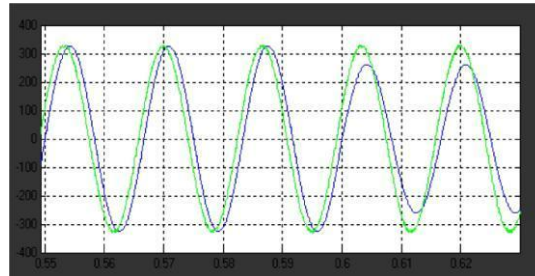

(h) Shunt inverter injected current

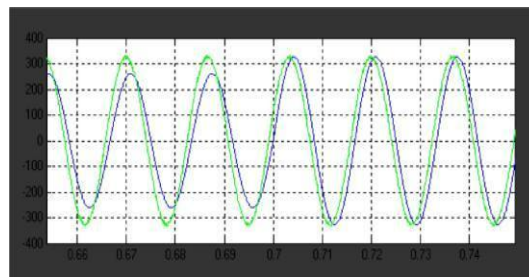

(i) Enlarged power angle δ during voltage sag condition.

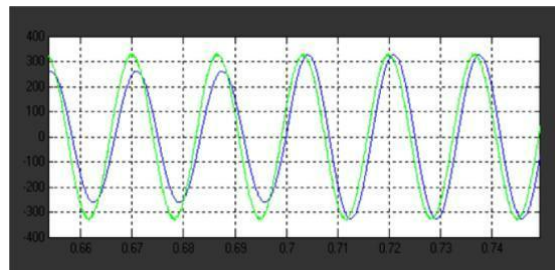

(j) Enlarged power angle δ during voltage swell condition. Fig. 6.2. Simulation results: active and reactive power flow through source, load, shunt, and series inverter utilizing proposed UPQC-S approach under voltage sag and swell conditions.

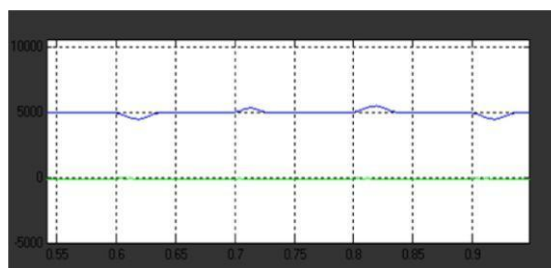

e) Enlarged power angle δ relation between supply and load voltages during steady-state condition.

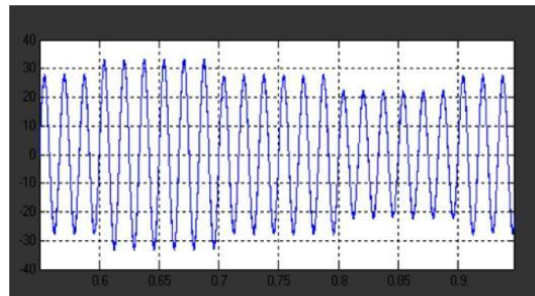

(f) Supply current.

(a) Source P and Q

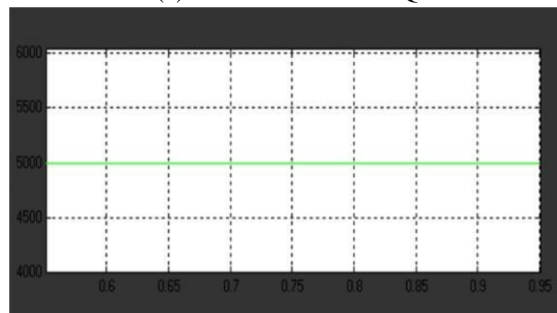

(b) Load P and Q.

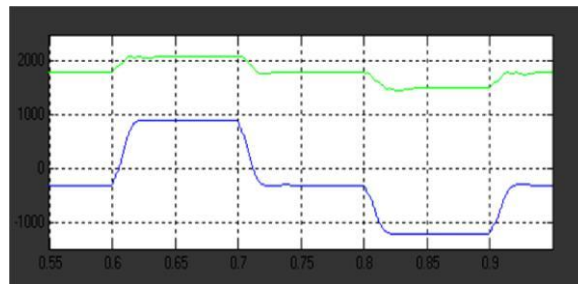

(c) Series inverter P and Q.

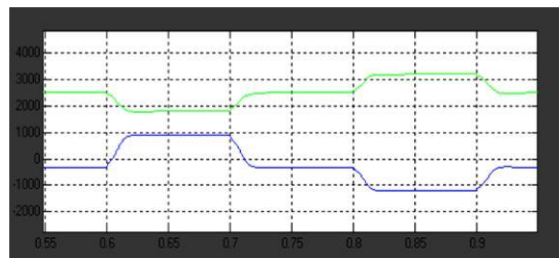

(d) Shunt inverter P and Q.

IV. CONCLUSION

Performance of Voltage sag/swell and load reactive power compensation have been done by UPQC with a PAC approach.

REFERENCES

- [1] R. C. Dugan, M. F. McGranaghan, and H. W. Beaty, Electrical Power Systems Quality.. New York: McGraw-Hill, 1996, p. 265.
- [2] C. Sankaran, Power Quality. Boca Raton, FL: CRC Press, 2002, p. 202.
- [3] R. A. Walling, R. Saint, R. C. Dugan, J. Burke, and L. A. Kojovic,

- Summary of distributed resources impact on power delivery systems, *IEEE Trans. Power Del.*, vol. 23, no. 3, pp. 1636–1644, Jul. 2008.
- [4] L. Gyugyi, —Unified power-flow control concept for flexible AC transmission systems, *IEEE – C Gene. Trans. Distr.*, vol. 139, no. 4, pp. 323–331, Jul. 1992.
- [5] N. G. Hingorani and L. Gyugyi, *Understanding FACTS: Concepts and Technology of Flexible AC Transmission Systems*. New York: IEEE Press, 2000, p. 432.
- [6] V. K. Sood, *HVDC and FACTS Controllers – Applications of Static Converters in Power Systems*. Boston, MA: Kluwer, 2004, p. 295.
- [7] A. Ghosh and G. Ledwich, *Power Quality Enhancement Using Custom Power Devices*. Boston, MA: Kluwer, 2002, p. 460.
- [8] B. Singh, K. Al-Haddad, and A. Chandra, —A review of active power filters for power quality improvement, *IEEE Trans. Ind. Electron.*, vol. 45, no. 5, pp. 960–971, Oct. 1999.
- [9] M. El-Habrouk, M. K. Darwish, and P. Mehta, —Active power filters: A review, *IEEE Electr. Power Appl.*, vol. 147, no. 5, pp. 403–413, Sep. 2000.
- [10] Doncker, C. Meyer, R. W. De, W. L. Yun, and F. Blaabjerg, —Optimized control strategy for a medium-voltage DVR— Theoretical investigations and experimental results, *IEEE Trans. Power Electron.*, vol. 23, no. 6, pp. 2746–2754, Nov. 2008.
- [11] C. N. Ho and H. S. Chung, —Implementation and performance evaluation of a fast dynamic control scheme for capacitor-supported interline DVR, *IEEE Trans. Power Electron.*, vol. 25, no. 8, pp. 1975–1988, Aug. 2010.
- [12] Y. Chen, C. Lin, J. Chen, and P. Cheng, —An inrush mitigation technique of load transformers for the series voltage sag compensator, *IEEE Trans. Power Electron.*, vol. 25, no. 8, pp. 2211–2221, Aug. 2010.
- [13] S. Subramanian and M. K. Mishra, —Interphase AC–AC topology for voltage sag supporter, *IEEE Trans. Power Electron.*, vol. 25, no. 2, pp. 514–518, Feb. 2010.
- [14] H. Fujita and H. Akagi, *IEEE Trans. Power Electron.*, vol. 13, no. 2, pp. 315–322, Mar. 1998.
- [15] V. Khadkikar and A. Chandra, —A new control philosophy for a unified power quality conditioner (UPQC) to coordinate load-reactive power demand between shunt and series inverters, *IEEE Trans. Power Del.*, vol. 23, no. 4, pp. 2522–2534, Oct. 2008.
- [16] M. Vilathgamuwa, Z. H. Zhang, and S. S. Choi, —Modeling, analysis and control of unified power quality conditioner, *in Proc. IEEE Harmon. Quality Power*, Oct. 14–18, 1998, pp. 1035–1040.
- [17] M. Gon, H. Liu, H. Gu, and D. Xu, —Active voltage regulator based on novel synchronization method for unbalance and fluctuation compensation, *in Proc. IEEE Ind. Electron. Soc (IECON)*, Nov. 5– 8., 2002, pp. 1374–1379.
- [18] M. S. Koor and M. Machmoum, —Simplified analogical control of a unified power quality conditioner, *in Proc. IEEE Power Electron. Spec. Conf. (PESC)*, Jun., 2005, pp. 2565–2570.
- [19] V. Khadkikar, A. Chandra, A. O. Barry, and T. D. Nguyen, —Analysis of power flow in UPQC during voltage sag and swell conditions for selection of device ratings, *in Proc. IEEE Electr. Computer Eng. (CCECE)*, May 2006, pp. 867–872.
- [20] B. Han, B. Bae, H. Kim, and S. Baek, —Combined operation of unified power-quality conditioner with distributed generation, *IEEE Trans. Power Del.*, vol. 21, no. 1, pp. 330–338, Jan. 2006.
- [21] H. R. Mohammadi, A. Y. Varjani, and H. Mokhtari, —Multiconverter unified power-quality conditioning system: MC-UPQC, *IEEE Trans. Power Del.*, vol. 24, no. 3, pp. 1679–1686, Jul. 2009.
- [22] I. Axente, J. N. Ganesh, M. Basu, M. F. Conlon, and K. Gaughan, —A 12-kVA DSP-controlled laboratory prototype UPQC capable of mitigating unbalance in source voltage and load current, *IEEE Trans. Power Electron.*, vol. 25, no. 6, pp. 1471–1479, Jun. 2010.
- [23] M. Basu, S. P. Das, and G. K. Dubey, —Investigation on the performance of UPQC-Q for voltage sag mitigation and power quality improvement at a critical load point, *IET Generat., Transmiss. Distrib.*, vol. 2, no. 3, pp. 414–423, May 2008.
- [24] V. Khadkikar and A. Chandra, —A novel control approach for unified power quality conditioner Q without active power injection for voltage sag compensation, *in Proc. IEEE Int. Conf. Ind. Technol. (ICIT)*, Dec. 15–17, 2006, pp. 779–784.
- [25] M. Yun, W. Lee, I. Suh, and D. Hyun, —A new control scheme of unified power quality compensator-Q with minimum power injection, *in Proc. IEEE Ind. Electron. Soc. (IECON)*, Nov. 2–6., 2004, pp. 51–56.